

Parts Manual

Mfg. No: 020490-00
3,100 PSI Husqvarna

Model Components	Page
Main Unit (316332).....	4
Pump (316275srv).....	8
Torque Specification Chart.....	10

Not For
Reproduction

Main Unit (316332)

Note: Unless noted otherwise, use the standard torque specifications

Mfg. No: 020490-00

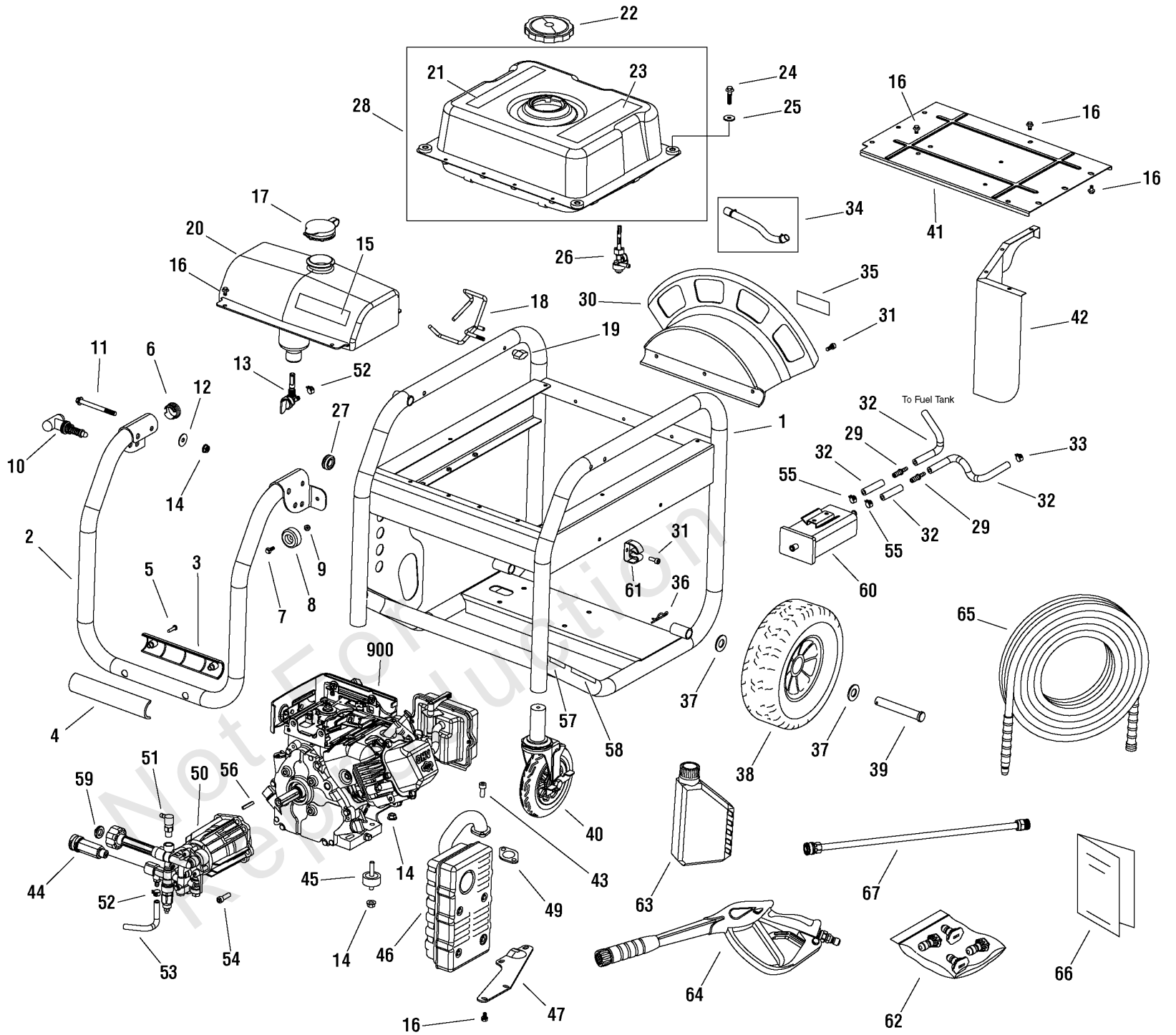

Main Unit (316332)

REF NO	PART NO	QTY	DESCRIPTION
1	316434GS		BASE
2	313252GS		HANDLE
3	316502GS		GRIP, Handle
4	316501GS		GRIP, Handle
5	-----		* SCREW, M5-0.8 x 20
6	316712GS		CAP, Plug
7	706865		SCREW, M6 x 18
8	316713GS		MOUNT, Vibration
9	-----		* NUT, M6 1.0
10	316732GS		T-KNOB
11	316508GS		SCREW
12	706926		WASHER
13	317106GS		VALVE, Chemical Tank
14	-----		* NUT, Flange, M8
15	316726GS		DECAL
16	706152		SCREW, M6 x 12
17	317542GS		CAP, Chemical Tank
18	316500GS		WIREFORM
19	194289GS		KNOB
20	316342GS		TANK, Chemical
21	316936GS		DECAL
22	316670GS		CAP, Fuel
23	316778GS		DECAL
24	706866		SCREW
25	312005GS		WASHER
26	209417GS		VALVE, Fuel
27	706895		GROMMET
28	319972GS		TANK, Fuel
29	317025GS		BARB, Hose
30	316374GS		WRAP, Hose
31	318992GS		SCREW
32	315017GS		HOSE, Vapor (cut to fit)
33	48031JGS		CLAMP
34	791745		LINE, Fuel
35	197798GS		DECAL
36	5025210YP		PIN, HAIR, .0915 X 1-7/8
37	-----		* WASHER, Flat, 5/8"
38	316406GS		WHEEL
39	317577GS		AXLE
40	316405GS		WHEEL, Caster
41	317058GS		HEATSHIELD
42	316505GS		HEATSHIELD
43	706921		KIT-HARDWARE MUFFLER
44	703825		FITTING
45	21217GS		MOUNT, Vibration
46	188301GS		MUFFLER
47	191785GS		BRACKET, Muffler
49	798516		GASKET

Footnotes:

Note:** Contact Engine Manufacturer for parts and service

Note:* Items without part numbers are common fasteners and are available at your local hardware store.

Main Unit (316332)

Note: Unless noted otherwise, use the standard torque specifications

Mfg. No: 020490-00

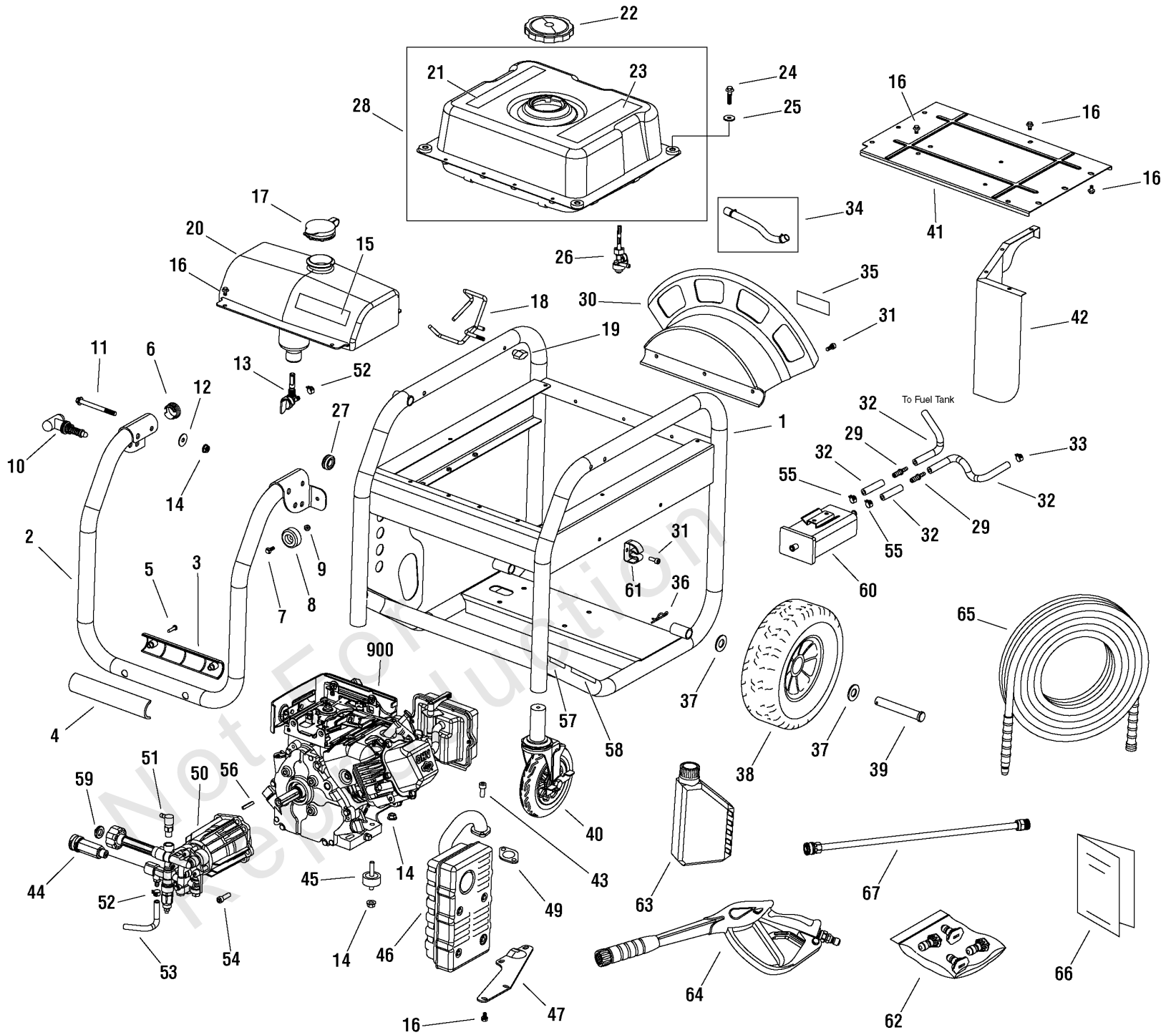

Main Unit (316332)

REF NO	PART NO	QTY	DESCRIPTION
50	317604GS		PUMP
51	208673GS		VALVE, Thermal Relief
52	48031GGS		CLAMP
53	A1040DGS		HOSE, Chemical
54	23707GS		SCREW
55	204024GS		CLAMP
56	23139DGS		KEY
57	208538GS		DECAL
58	316727GS		DECAL
59	B2384GS		FILTER, Garden Hose
60	316783GS		CARBON CANISTER
61	316503GS		CLIP
62	314075GS		KIT-QC NOZZLES
--	198841GS		NOZZLE, QC Black
--	195983AAGS		NOZZLE-QC RED
--	195983RGS		NOZZLE, QC White
--	195983TGS		NOZZLE, QC Yellow
63	316768GS		OIL BOTTLE
64	316157GS		GUN
65	316465GS		HOSE
66	316330GS		MANUAL, Operator
67	200595GS		EXTENSION
900	----		** ENGINE
--	316782GS		WRENCH, Allen -(Not Illustrated)
--	317365GS		OIL FUNNEL -(Not Illustrated)
--	6039		PUMP SAVER -(Optional Accessory - Not Included)
--	705001		KIT-O-RING -(Optional Accessory - Not Included)

Footnotes:

Note:** Contact Engine Manufacturer for parts and service

Note:* Items without part numbers are common fasteners and are available at your local hardware store.

Pump (316275srv)

Note: Unless noted otherwise, use the standard torque specifications

Mfg. No: 020490-00

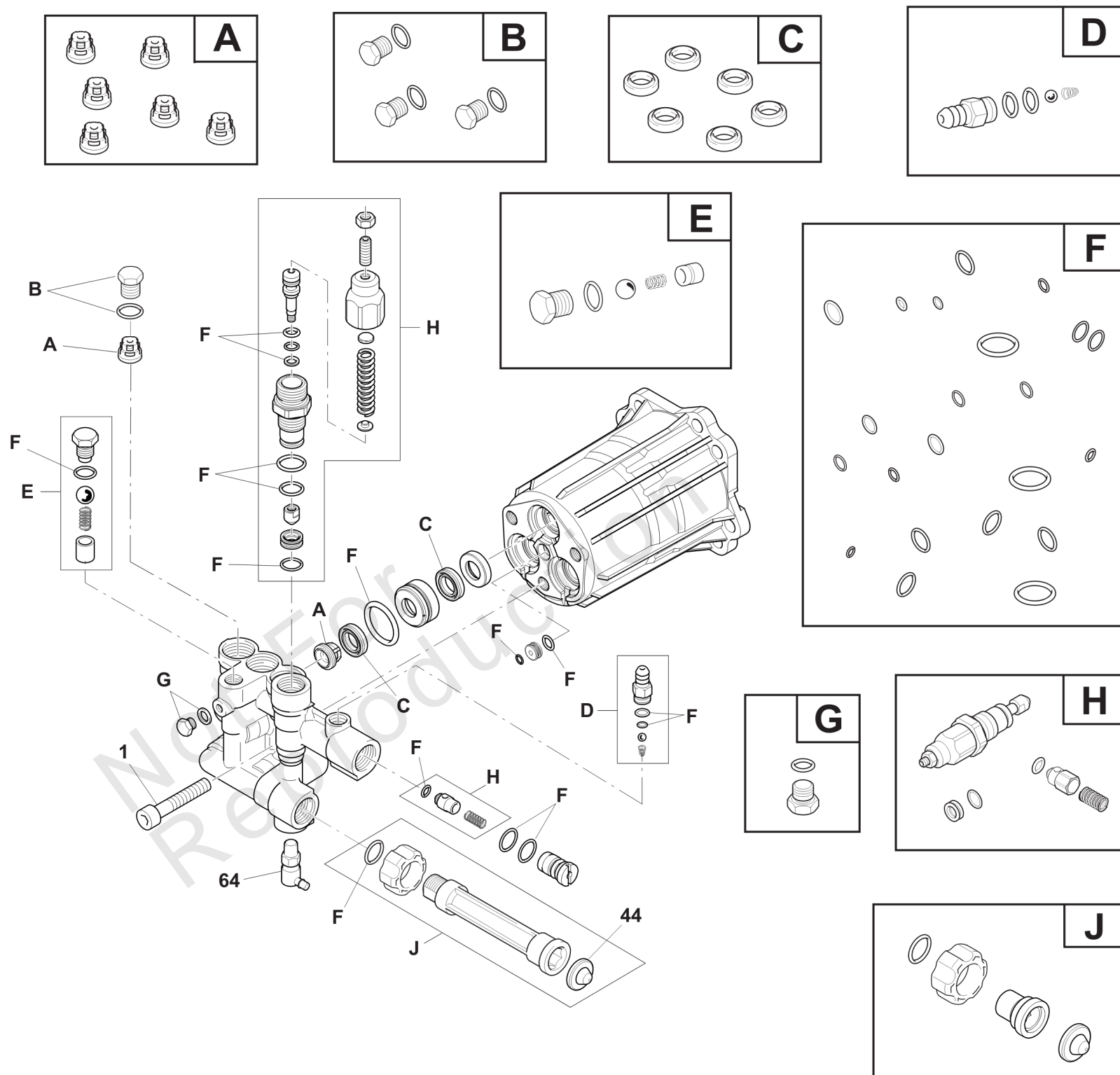

Pump (316275srv)

REF NO	PART NO	QTY	DESCRIPTION
1	204087GS		SCREW
44	B2384GS		FILTER, Garden Hose
64	208673GS		VALVE, Thermal Relief
A	204082GS		KIT, Check Valve
B	317056GS		KIT, Plug
C	204084GS		KIT, Water Seal
D	317787GS		KIT, Chemical Inj.
E	317788GS		KIT, Easy Start
F	317843GS		KIT, O- Ring
G	200350GS		SCREW, Grub
H	706610		KIT, Unloader
J	201496GS		KIT, Water Inlet
--	6039		PUMP SAVER -(Optional Accessory - Not Included)

Not For Reproduction

Hardware Identification & Torque Specifications

Torque Specification Chart								
FOR STANDARD METRIC MACHINE HARDWARE (Tolerance ± 20%)								
Property Class	5.6		8.8		10.9		12.9	
	Class 5.6		Class 8.8		Class 10.9		Class 12.9	
Size Of Hardware	in/lbs	Nm.	in/lbs	Nm.	in/lbs	Nm.	in/lbs	Nm.
	ft/lbs		ft/lbs		ft/lbs		ft/lbs	
M3	5.88	.56	13.44	1.28	19.2	1.80	22.92	2.15
M4	13.44	1.28	30.72	2.90	43.44	4.10	52.56	4.95
M5	26.4	2.50	60.96	5.75	5.97	8.10	7.15	9.7
M6	44.64	4.3	7.3	9.9	10.3	14	12.1	16.5
M7	5.2	7.1	12.1	16.5	16.9	23	19.9	27
M8	7.7	10.5	17.7	24	25	34	29	40
M10	15	21	35	48	50	67	59	81
M12	26	36	61	83	86.2	117	103	140
M14	42	58	101	132	136	185	162	220
M16	64	88	147	200	210	285	250	340
M18	89	121	202	275	287	390	346	470
M20	126	171	290	390	405	550	486	660
M22	169	230	390	530	559	745	656	890
M24	217	295	497	375	708	960	840	1140
M27	320	435	733	995	1032	1400	1239	1680
M30	435	590	995	1350	1401	1900	1681	2280
M33	590	800	1349	1830	1902	2580	2278	3090
M36	759	1030	1740	2360	2441	3310	2935	3980
M39	988	1340	2249	3050	3163	4290	3798	5150

Torque Specification Chart						
FOR STANDARD MACHINE HARDWARE (Tolerance ± 20%)						
Hardware Grade	No Marks		SAE Grade 5		SAE Grade 8	
	SAE Grade 2		SAE Grade 5		SAE Grade 8	
Size Of Hardware	in/lbs	Nm.	in/lbs	Nm.	in/lbs	Nm.
	ft/lbs		ft/lbs		ft/lbs	
8-32	19	2.1	30	3.4	41	4.6
8-36	20	2.3	31	3.5	43	4.9
10-24	27	3.1	43	4.9	60	6.8
10-32	31	3.5	49	5.5	68	7.7
1/4-20	66	7.6	8	10.9	12	16.3
1/4-28	76	8.6	10	13.6	14	19.0
5/16-18	11	15.0	17	23.1	25	34.0
5/16-24	12	16.3	19	25.8	29	34.0
3/8-16	20	27.2	30	40.8	45	61.2
3/8-24	23	31.3	35	47.6	50	68.0
7/16-14	30	40.8	50	68.0	70	95.2
7/16-20	35	47.6	55	74.8	80	108.8
1/2-13	50	68.0	75	102.0	110	149.6
1/2-20	55	74.8	90	122.4	120	163.2
9/16-12	65	88.4	110	149.6	150	204.0
9/16-18	75	102.0	120	163.2	170	231.2
5/8-11	90	122.4	150	204.0	220	299.2
5/8-18	100	136	180	244.8	240	326.4
3/4-10	160	217.6	260	353.6	386	525.0
3/4-16	180	244.8	300	408.0	420	571.2
7/8-9	140	190.4	400	544.0	600	816.0
7/8-14	155	210.8	440	598.4	660	897.6
1-8	220	299.2	580	788.8	900	1,244.0
1-12	240	326.4	640	870.4	1,000	1,360.0

The guides and ruler furnished below are designed to help you select the appropriate hardware.



Nut, M8

Thread Diameter (mm)

Inside Diameter (in) Threads per inch

Nut, 1/2-16



Screw, M8- 1.25 x 25

Thread Diameter (mm) Distance between threads (mm) Body Length (mm)

Body Diameter Threads per inch Body Length (in)

Screw, 1/2- 16 x 2



Standard Hardware Sizing

When a washer or nut is identified as 1/2" (M8), this is the *Nominal size*, meaning the *inside diameter* is 1/2 inch (8mm metric thread diameter); if a second number is present it represents the *threads per inch* (distance between threads).

When bolt or capscrew is identified as 1/2 - 16 x 2" (M8 - 1.25 x 50), this means the *Nominal size*, or body diameter is 1/2 inch (8mm metric thread diameter), the second number, 16, represents the *threads per inch*, (*distance between threads*). The final number is the body length of the bolt or screw, 2 inches (50mm).

NOTES

- These torque values are to be used for all hardware excluding: locknuts, self-tapping screws, thread forming screws, sheet metal screws and socket head setscrews.
- Recommended seating torque values for locknuts:
 - for prevailing torque locknuts - use 65% of grade 5 torques.
 - for flange whizlock nuts and screws - use 135% of grade 5 torques.
- Unless otherwise noted on assembly drawings, all torque values must meet this specification.

Common Hardware Types

Hex Head Capscrew



Washer



Carriage Bolt



Hex Nut

Wrench & Fastener Size Guide

1/4" Bolt or Nut Wrench—7/16"	5/16" Bolt or Nut Wrench—1/2"	3/8" Bolt or Nut Wrench—9/16"	7/16" Bolt or Nut Wrench (Bolt)—5/8" Wrench (Nut)—11/16"	1/2" Bolt or Nut Wrench—3/4"
M6 Bolt or Nut Wrench—10mm	M8 Bolt or Nut Wrench—13mm	M10 Bolt or Nut Wrench—17mm	M12 Bolt or Nut Wrench—19mm	M14 Bolt or Nut Wrench—22mm

